

Luftbehandlungsgeräte

Wand- und Deckengeräte Artikelgruppe 1.52, 1.53

Geräte und Anbauteile in der Seitenansicht

Baugröße 35

Stand: 11/2004

Maßstab 1:1

CAD-Nr. 218346

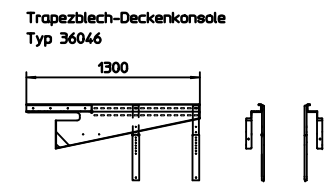
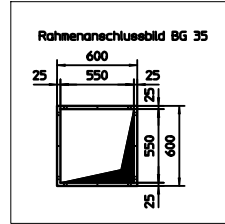
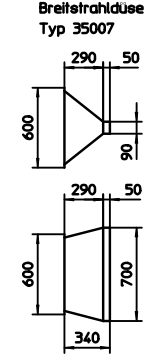
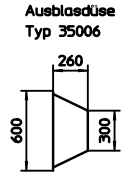
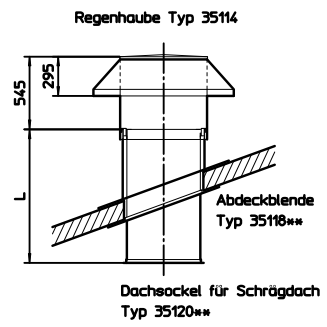
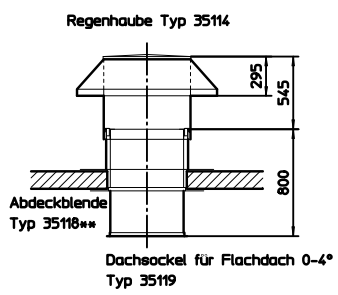
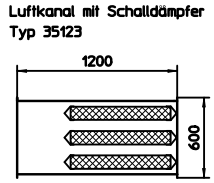
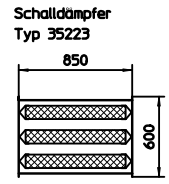
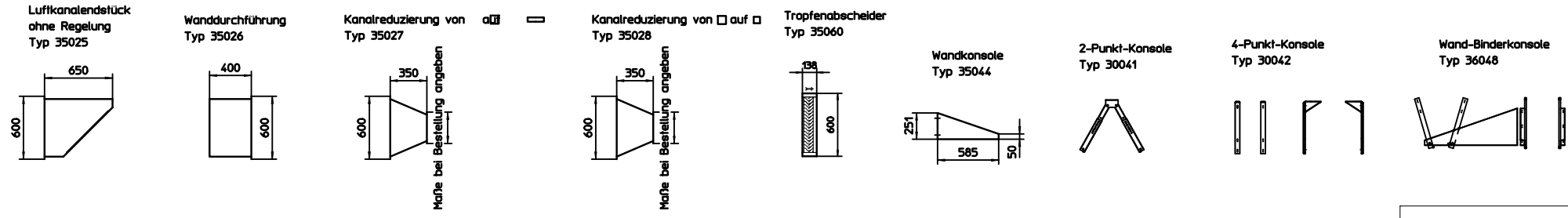
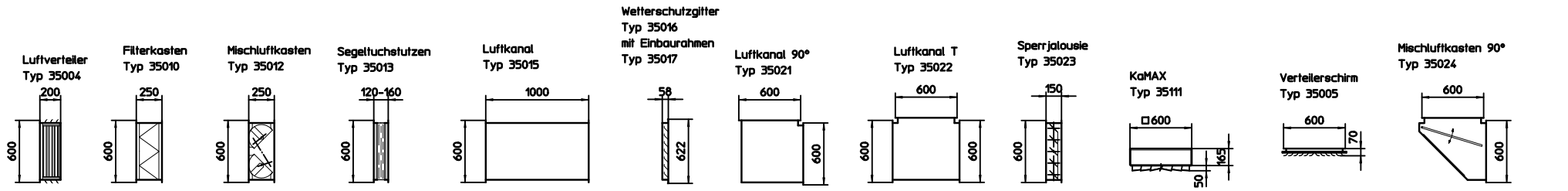

Anzahl	Stamm-Nr.	Index	Änderung	Name	Datum
	Edge-Nr.	3	Änderung geändert	dr	21.09.09
		2	Überarbeitet	tp	18.10.04
Projekt-Nr.	49794, Lingen Tel. 0591-768-0	Formal	Art-Gr.	SAP-Nr.	CAD-Nr.
Änder-Nr.	End: 1 210909	dx			218346
Auftr-Nr.					3
STL-Nr.		Gepr.	1	152	
		Werkstoff			
		Preis	15233	Kom.	
				Zu-Abw.	ISO 2768-m
					Revisionsdokumentation
<b>Lufterhitzer Anbauteile BG 35</b>					